

Extractorhoods
Instructions for installation and use

IT	MANUALE D' USO	3
EN	USER MANUAL	6
DE	BEDIENUNGSANLEITUNG	9
FR	MANUEL D'UTILISATION	12
NL	GEBRUIKSAANWIJZING	15
SE	ANVÄNDARMANUAL	18
ES	MANUAL DE USO	21

EN Recommendations and Suggestions

- The Instructions for Use apply to several versions of this appliance. Accordingly, you may find descriptions of individual features that do not apply to your specific appliance.
- The manufacturer will not be held liable for any damages resulting from incorrect or improper installation.
- The minimum safety distance between the cooker top and the extractor hood is 650 mm (some models can be installed at a lower height, please refer to the paragraphs on working dimensions and installation).
- Check that the mains voltage corresponds to that indicated on the rating plate fixed to the inside of the hood.
- For Class I appliances, check that the domestic power supply guarantees adequate earthing. Connect the extractor to the exhaust flue through a pipe of minimum diameter 120 mm. The route of the flue must be as short as possible.
- Do not connect the extractor hood to exhaust ducts carrying combustion fumes (boilers, fireplaces, etc.).
- If the extractor is used in conjunction with non-electrical appliances (e.g. gas burning appliances), a sufficient degree of aeration must be guaranteed in the room in order to prevent the backflow of exhaust gas. The kitchen must have an opening communicating directly with the open air in order to guarantee the entry of clean air. When the cooker hood is used in conjunction with appliances supplied with energy other than electric, the negative pressure in the room must not exceed 0,04 mbar to prevent fumes being drawn back into the room by the cooker hood.
- In the event of damage to the power

cable, it must be replaced by the manufacturer or by the technical service department, in order to prevent any risks.

- If the instructions for installation for the gas hob specify a greater distance specified above, this has to be taken into account. Regulations concerning the discharge of air have to be fulfilled.
- Use only screws and small parts in support of the hood.

Warning: Failure to install the screws or fixing device in accordance with these instructions may result in electrical hazards.

- Connect the hood to the mains through a two-pole switch having a contact gap of at least 3 mm.

USE

- The extractor hood has been designed exclusively for domestic use to eliminate kitchen smells.
- Never use the hood for purposes other than for which it has been designed.
- Never leave high naked flames under the hood when it is in operation.
- Adjust the flame intensity to direct it onto the bottom of the pan only, making sure that it does not engulf the side.
- Deep fat fryers must be continuously monitored during use: overheated oil can burst into flames.
- Do not flambé under the range hood; risk of fire.
- This appliance can be used by children aged from 8 years and above and persons with reduced physical, sensory or mental ca-

pabilities or lack of experience and knowledge if they have been given supervision or instruction concerning use of the appliance in a safe way and understand the hazards involved. Children shall not play with the appliance. Cleaning and user maintenance shall not be made by children without supervision.

“CAUTION: Accessible parts may become hot when used with cooking appliances.”

Maintenance

- The symbol on the product or on its packaging indicates that this product may not be treated as household waste. Instead it shall be handed over to the applicable collection point for the recycling of electrical and electronic equipment. By ensuring this product is disposed of correctly, you will help prevent potential negative consequences for the environment and human health, which could otherwise be caused by inappropriate waste handling of this product. For more detailed information about recycling of this product, please contact your local city office, your household waste disposal service or the shop where you purchased the product.
- Switch off or unplug the appliance from the mains supply before carrying out any maintenance work.
- Clean and/or replace the Filters after the specified time period (Fire hazard).- Activated charcoal filter W these filters are not washable and cannot be regenerated, and must be replaced approximately every 4 months of operation, or more frequently with heavy usage.
- Grease filters Z The filters must be cleaned every 2 months of operation, or more frequently for particularly heavy usage, and can be washed in a dishwasher.

DISMANTLING/ CLEANING SOUNDPROOFING ELEMENTS

- Remove the Metal grease filters.
- Remove the Activated charcoal filter, using the hooks provided.
- Extract the Soundproofing Elements by pressing on them.
- Clean them with a damp cloth and replace them, first making sure that they are completely dry.
- Replace the Activated charcoal filters.
- Replace the Metal grease filters

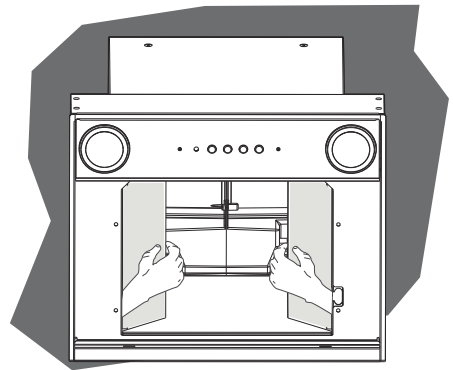

Caution:

Be careful not to damage the Soundproofing Elements.

CLEANING METAL SELF-SUPPORTING GREASE FILTERS

- * The filters must be cleaned every 10-15 days of operation, or more frequently for particularly heavy usage, and can be washed in a dishwasher.
- * Remove the filters one at a time by pushing them towards the back of the group and pulling down at the same time.
- * Wash the filters, taking care not to bend them. Allow them to dry before refitting.
- * When refitting the filters, make sure that the handle is visible on the outside.

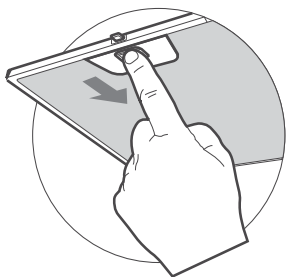

LIGHTING / LIGHT REPLACEMENT 20 W Halogen light

- * Remove the snap-on lamp cover by levering it from under the metal ring, supporting it with one hand.
- * Remove the halogen lamp from the lamp holder by pulling gently.
- * Replace the lamp with a new one of the same type, making sure that you insert the two pins properly into the housings on the lamp holder.
- * Replace the snap-on lamp cover.

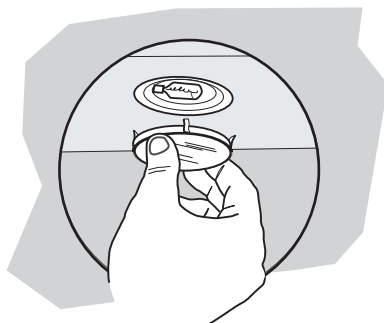

CHANGING THE ACTIVATED CHARCOAL FILTER

- * This cannot be washed or regenerated, and must be changed at least once every 4 months, or more frequently in the case of particularly intensive use.
- * Remove the Metal grease filters.
- * Remove the Suction Panel by unfastening the 4 screws at the corners.
- * Remove the saturated Activated charcoal filter, using the hooks provided.
- * Fit the new Filter, hooking it into place.
- * Replace the Panel and the Metal grease filters.

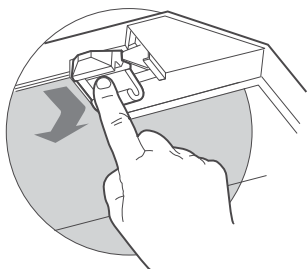

Regular maintenance and cleaning will ensure good performance and reliability, while extending the working life of the chimney.

Baffle Filters

- * Have to be cleaned minimum once or twice in 10 to 15 days depending upon usage or more frequently depending on type of cooking.
- * These are easily washable with warm water and mild detergent and are dishwasher safe. They can withstand frequent washing cycles.
- * Baffle filter can be cleaned as easily as utensils.
- * Baffle filters are non-clogging as they use cut & chop technology to separate oil particles from vapours making extraction as effective as possible.

PULL KNOBS



Charcoal filter

- * These filters are used in re-circulation mode & are helpful in absorbing cooking odour. The charcoal filter cannot be washed & have to be replaced as soon as they get saturated.

TURN ANTICLOCK



Cleaning of Hood

- * When cleaning the hood unplug the connection of the chimney from the electric supply.
- * It is recommended to use a damp cloth and mild liquid household cleaner .
- * Never use a wet cloth or sponge or running water.
- * Never use thinner or products containing alcohol, as they might damage the exterior paint work.
- * Never use abrasive cleaning material, in particular when cleaning stainless steel surfaces(to avoid scratches).

Benefits of regular maintenance and cleaning.

- * Regular cleaning of baffle filter greatly improves the efficiency of the chimney.
- * Regular cleaning helps to reduce oil deposition on baffle filters thus avoids the potential danger of electric chimney catching fire.
- * Regular cleaning also helps the motor/rotor to remain functional. Initial oil deposits could eventually travel to the motor/rotor, jamming them & making non-functional.
- * It is advise to call the authorised service representative regularly to clean the chimney and it's internal assembly**.

USE CONTROL PANEL

Touch Control Panel



Soft Touch Control Panel

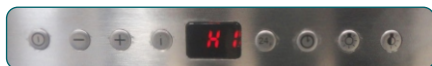

Backlight Soft Push Control Panel



Soft Push Control Panel

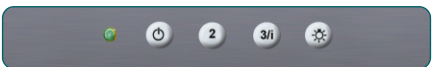

Feather Touch Control Panel

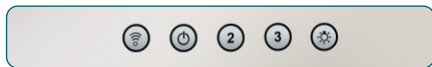

Push Buttons Control Panel

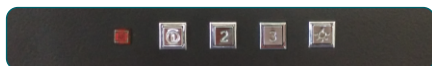

FUNCTIONS

⓪	⓪	A
1		B
2		C
3		D
-		E
+		F
i		G
3/i		H
24	24 _F	I
⌚		J
📶		K
☀️		L
☀️		M

A: Turns the motor OFF

B: Turns the motor ON at speed one

C: Turns the motor ON at speed two

D: Turns the motor ON at speed three

E: Decrease speed by one level

F: Increase speed by one level

G: Intensive speed/ Maximum hood speed

H: When pressed/touched for < 3 sec the hood will start at third speed. When pressed / touched for > 3 sec the hood will start at intensive speed.

The hood will remain in this speed for 10 mins. And will come back to the previous speed after 10 mins. The intensive mode can be disabled by pressing/touching the same button for > 3 sec.

I: Starts the 24H function, in which the motor starts at a speed that allows suction of 100 m³/h for 10 minutes per hour. This mode cannot be activated if Intensive or Delay modes are active. To deactivate it, press the same button or button A.

When pressed/touched for > 3 sec, will clear the filter clean indication flashing on the display.

TROUBLE SHOOTING GUIDE

1. The chimney does not suck the vaporous / smoke properly:
 - * Are the Charcoal Filters saturated (In Recirculation Mode)?
 - * If Yes, Replace Charcoal Filter. Call Toll free no.: **1800 209 2096** (Office Hours) for replacing charcoal filters.
 - * Is the outlet of the duct blocked?
 - * Check and clean the duct.
2. The chimney does not start:
 - * Is there a power failure?
 - * Is the power supply at the electric supply point proper?
 - * Has the chimney been "ON" continuously for more than 4 hours, thereby causing the thermal overload protection to trip?
 - * If this has indeed happened, the chimney will automatically re-start once it has cooled.

KNOW YOUR KITCHEN CHIMNEY

1. How does a chimney work?

A chimney is fitted right above the cooking appliance. When switched "ON" it sucks all the oil, smoke, spices etc generated during cooking. The oil gets trapped into modular filters & odour/ smoke is filtered & re-circulated into the room or they are thrown out of room through duct.

2. Does a chimney really work? How does it differ from an exhaust fan?

Yes, a chimney is very effective. It not only throws/ purifies the air but it also traps oil & spices. This not only keeps the kitchen air clean it also prevents blackening of walls/ furniture which can't be done by exhaust fan.

3. How is it installed?

It can be fitted in ducting or recycling mode. In the ducting mode, heavier particles of oil/grease/spice are trapped in the baffle/mesh filter, and smoke/fumes are ducted out of the house. In case ducting is

not feasible, the chimney can also be fitted in a re- cycling mode (except very few models). In this mode, heavier particles of oil/grease/spice are trapped in the baffle / mesh filter and smoke/fumes are filtered through activated charcoal filter. Clean & de-odourised air is then re-circulated into the room.

4. Who will install the chimney ?

A skilled technician from authorised service center should be called to install the chimney.

5. Is ducting compulsory ?

No, but it is always advisable as the efficiency and suction capacity of the chimney increases, and there is no recurring cost of charcoal filters.

6. Are there separate models for re-cycling and ducting ?

No. Most of the Blaupunkt models can be used in both modes of installation.

7. What should be the size of the duct pipe, length of ducting & the number of bends for effective suction?

Minimum pipe diameter should be 110 mm for traditional model and 120mm for decorative models. Recommended ducting length should be 8 to 9 feet and maximum two bends.

8. Can a smaller diameter pipe be fitted ?

No. using a smaller diameter pipe causes a back pressure to act on the motor. The warranty is void in such cases.

9. Is ducting possible in my house ?

We'll be pleased to send our Representative to ascertain the same.

10. At what height should the chimney be fitted ?

The chimney should be fitted at a height of not less than 65cms from the burners and ideally not more than 75cms.

11. Life and cost of charcoal filter ?

Typically, the charcoal filters last around 3-4 months. However, this period may become vary depending on the usage. Cost should be confirmed with the local service center.

12. How to maintain the chimney ?

The Mesh filters have to be cleaned in warm detergent water every 8-10 days, and the Baffle filters have to be cleaned in warm detergent water every 10-15 days depending on usage. In case of re-cycling the charcoal filters have to be replaced every 3-4 months, depending on the usage.

13. How do I select the model ?

Our chimneys are categorized into Traditional (Basic or Straight Line), Decorative and Collection, which add to the aesthetics of the kitchen. The suction requirements of the chimney depend on a lot of parameters like the cooking habits & kitchen size. We would be happy to send our Representative to help you choose the right product.

14. What is the suction capacity available ?

Blaupunkt chimneys are available in a range of suction capacities, from 300 m³/hr to 1200 m³/hr. Our chimneys are categorized into Traditional (Basic or Straight Line), Decorative and Collection, which add to the aesthetics of the kitchen. The suction requirements of the chimney depend on a lot of parameters like the cooking habits & kitchen size.

15. Is it true that the chimney makes a lot of noise ?

No. All Blaupunkt chimneys generate noise levels tolerable to human ears. Typically the noise level are ranging from 40db(A) to 67db(A) depending upon the speed of operations and suction capacity of the kitchen chimney.

16. What is the electric consumption ?

It depends on the individual models. Most of the models consume approx. 1 unit for every 3-4 hrs. of operation.

17. What is a Baffle filter ?

How does it differ from an ordinary (mesh) filter? The Blaupunkt patented Baffle Filter is a Stainless Steel filter with a unique structural design of curves and cup-like strips. This cut & chop technology used in the design ensures greater trapping of oil/grease /spice particles, easier cleaning and lifetime durability. The non-clogging feature ensures the optimum suction of the chimney.

18. What are the sizes available ?

Blaupunkt chimneys are available in widths of 60cm, 75cm, 90cm and 120cm.

19. What are the installation/service charges?

You can confirm with the local service center .

20. What is the warranty period?

We have warranty period of one year depending on the kitchen chimney model.

AFTER SALES SERVICE

Before calling the Toll Free Number **1800 209 2096** (Office Hours) to Register the Complaint:

- * Check the ' Trouble Shooting Guide' given above to see if you can eliminate the problem yourself.
- * Re-start the chimney to check if correct operation is restored.

On Calling the Toll Free Number: **1800 209 2096** (Office Hours)

Please give the following information:

- * Your complete address with landmark and contact numbers.

- * One Year Warranty Number.
- * Model of chimney.
- * Nature of malfunction.
- * Please make a note of the Call Number allotted to you.

Please do not allow any unauthorized person to service or repair the chimney. This may affect the safety and quality of the product.

ONE YEAR WARRANTY TERMS & CONDITIONS

Blaupunkt, undertakes that all the machines manufactured & marketed by Blaupunkt are sold after thorough inspection by the quality control department. Blaupunkt extends this warranty only in the case of defects in manufacturing and/or workmanship and undertakes to replace / repair, at the sole discretion of Blaupunkt, any parts, except charcoal filters, bulbs, glass parts, items which are subject to normal wear & tear due to operation, which upon examination by Blaupunkt reveal to be having manufacturing defects. The warranty of this chimney is One Year Warranty from the date of purchase.

This warranty is subject to the terms and conditions mentioned below:

1. To avail warranty services it is mandatory for the products to be registered within the period of 30 days from the date of purchase. The registration form should be duly filled and send to Blaupunkt along with copy of invoice.
2. Warranty will be valid only on producing One Year Warranty Letter and Bill/ Invoice.
3. In case if warranty is not registered within 30 days from the date of purchase, the One Year Warranty will be null & void.
4. To register for One Year Warranty after 30 days, submitting proof of invoice along with payment of the charges would be on actual basis is mandatory. The registration of One Year Warranty will be at sole discretion of Blaupunkt.
5. Warranty is valid from the date of purchase of the chimney.
6. Only Motor and Rotor are covered under this warranty. However, warranty does not cover consumables like bulbs, Switches / Knobs, charcoal filters, outer body, metal / glass / plastic parts , filter locks etc of the chimneys.
7. Touch Button, Switch PCB Control / Main PCB carries a Warranty of 1 Year From Date of Purchase
8. Glass or glass parts are not covered under warranty from date of purchase.
9. Visit made by Blaupunkt Technician for product assistance within a period of one year from date of purchase would be free (Also Refer point No 16) & there after levied charges would be on actual basis will be applicable, as and when the customer calls for product assistance. However the spare parts covered under warranty will not attract any charges during the life of the product.
10. This appliance is designed purely for domestic use by private individuals at home only. Warranty is not applicable for commercial use of product.
11. It is mandatory to get the product serviced / cleaned at least twice a year through Authorized Service Centre by calling on Toll Free No.:**1800 209 2096** (Office Hours)
12. The warranty becomes null and void in following cases:
 - o Installation / Service / Repairs / Modification carried out by persons other than those authorized by Blaupunkt.
 - o Failure due to use of non-genuine parts.
 - o Removal, alteration or tampering of serial no. of chimney and its components.
 - o Change of ownership.
 - o Damages occurred due to improper external electric circuits and failure due to erratic power supply.
 - o Damage resulting to the chimney due to operation in an abnormally corrosive Alkaline, Acidic atmosphere or use of harmful chemical
 - o Failure due to misuse / negligence

/accident / action of pests, rodents / or act of god / lightening / fire / flood/ earthquake and fire due to electrical short circuit.

oAppliance taken out of country.

13. Blaupunkt undertakes no liability in the matter of consequential loss and / or damages caused to the customer or third party due to failure / malfunction of the chimney. Blaupunkt's obligation under this warranty shall be limited to repairing or replacing the defective parts only.

14. Any routine maintenance / cleaning / servicing visit would not be covered under this warranty, and would be provided on chargeable basis as per prevailing rates / charges.

15. Whether defective item or components are to be replaced / repaired shall be left to the sole discretion of Blaupunkt. In case of replacement of a part, the defective part becomes the property of Blaupunkt.

16. In case of no authorized service center present in the area/ or in case service is to be provided beyond municipal/city limits, then services would be provided from the nearest authorized services area, a fixed charge would be applied (subject to distance) in addition to the actual to & fro charges along with local conveyance by the shortest route. However in order to avail the services, the products could also be brought at the nearest authorized service center by the customer at their own expense. If the product is taken for service a service centre, then actual Octroi (wherever applicable) will be borne by customer along with transportation cost.

17. In case of change of location from the original place of purchase at any given point in time, then the product would attract a minimum transfer cost of the charges would be on actual basis. The information should be given to Blaupunkt corporate office for record. (The money needs to be paid to the local authorized service center as per company's instruction). This does not include the cost of re-installation, which would be carried out by Authorised Service Center at the prevailing rates.

18. Services would be provided within normal working hours (0900 to 1830 hrs) on regular working days only except sundays & public holidays.

19. The decision of Blaupunkt with regards to the settlement of all claims under this warranty shall be final.

Service

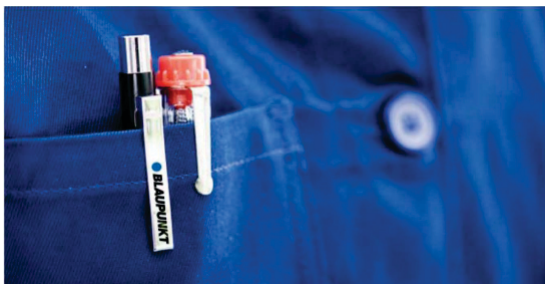

Blaupunkt integrated kitchen appliances/customer services:

Tel: 180 2092096

customer_service@hepindia.com

You have chosen a piece of premium kitchen equipment with Blaupunkt appliances. Our professional service is available to assist you after the purchase. Our qualified employees are pleased to remain at your disposal. Our customer service experts for Blaupunkt integrated kitchen appliances will professionally answer all questions about the appliances. Here you will receive all the information on handling, functions and performance.



Your direct route to Blaupunkt.
www.blaupunkt-einbaugeräte.com



Convincing quality with Blaupunkt guarantee.

Blaupunkt kitchen appliances are exclusively produced from the best materials and according to the highest working standards. Blaupunkt provides a two-year manufacturer's guarantee on every appliance and every repair carried out by the Integrated kitchen appliances customer service.



More original: Accessories and spare parts.

Original spare parts, extensive accessories and tested detergents and care products can be bought from our competent employees.



In your vicinity - and fast. Our specialists from Blaupunkt. With a nationwide service network and approximately 700 highly qualified technicians, we can guarantee that our specialists are always quickly on location in case of repair. The standard time is within 48 hours.